

PSPO Notice Locations Plans

See the PSPO Locations Document for notice specifications and fitting information.

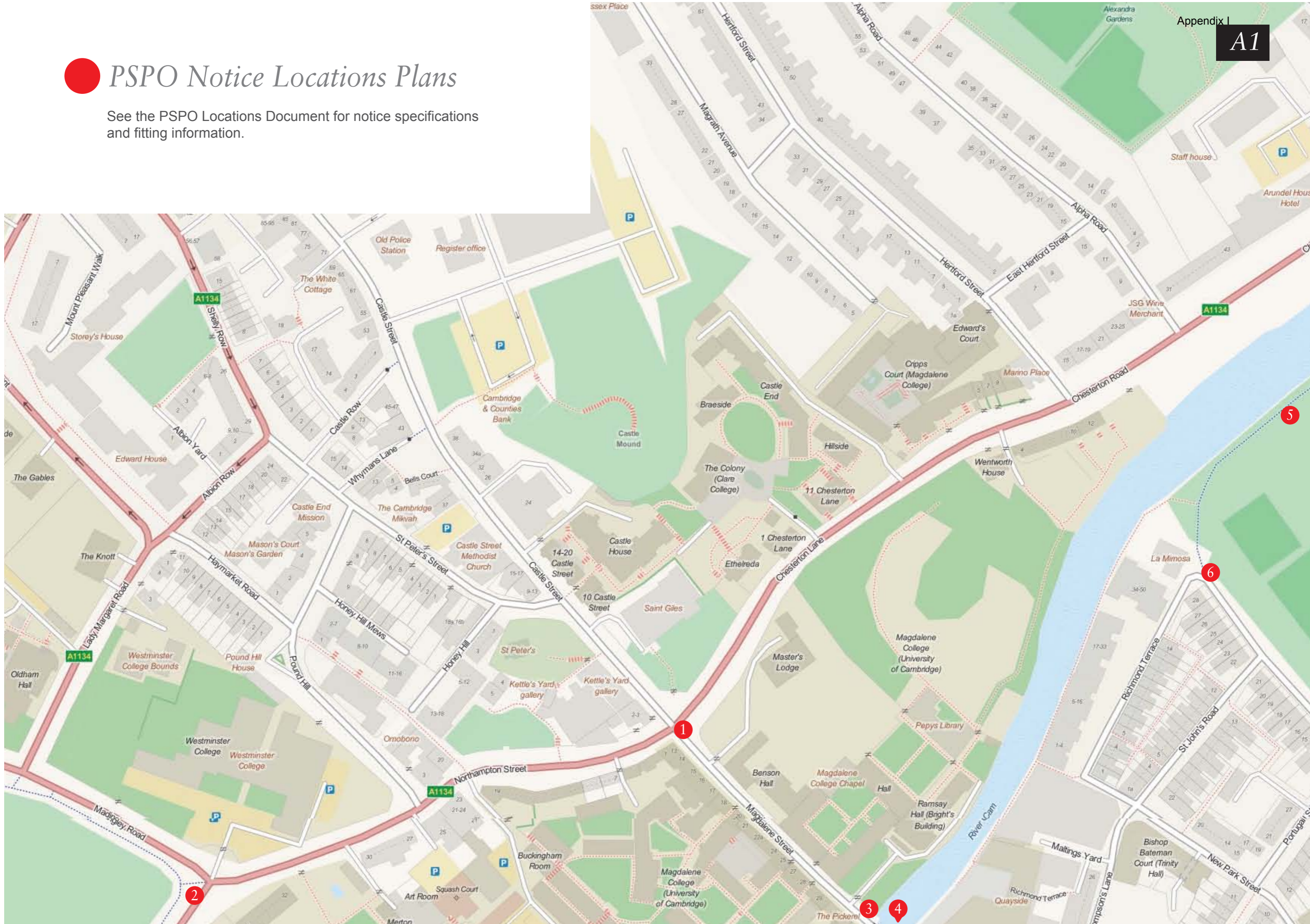

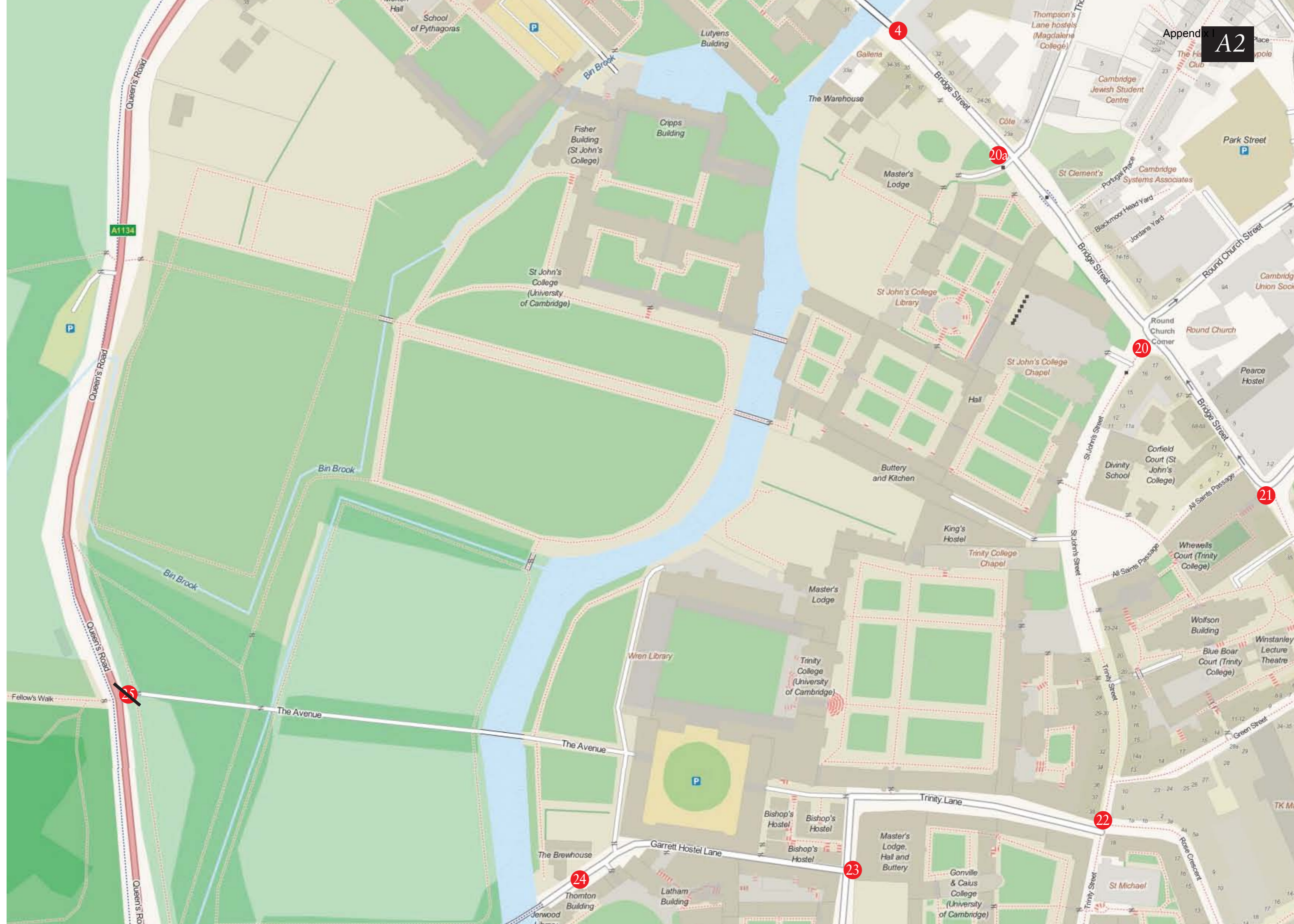



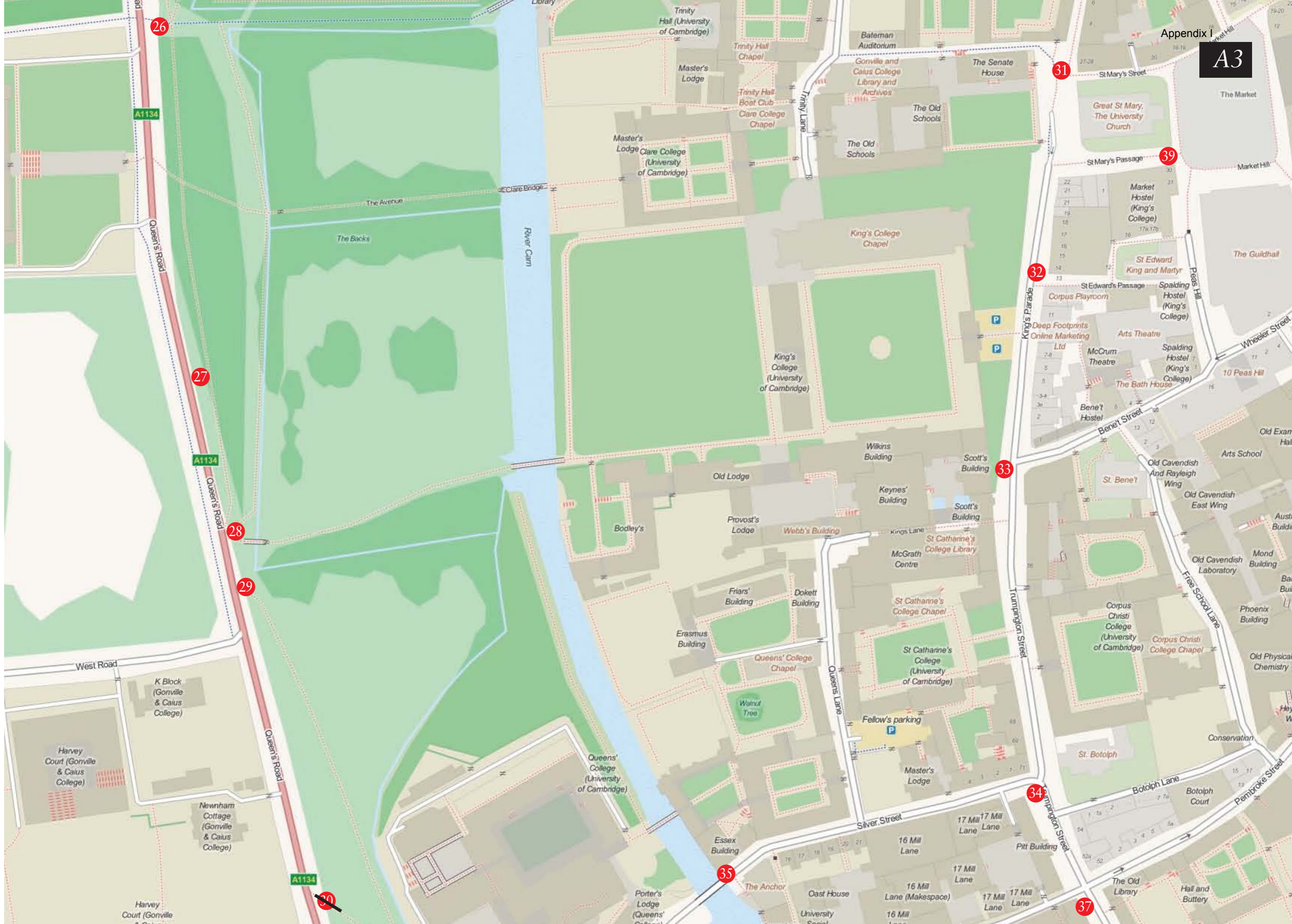

26

27

28

29

30

31

32

33

35

34

37

39

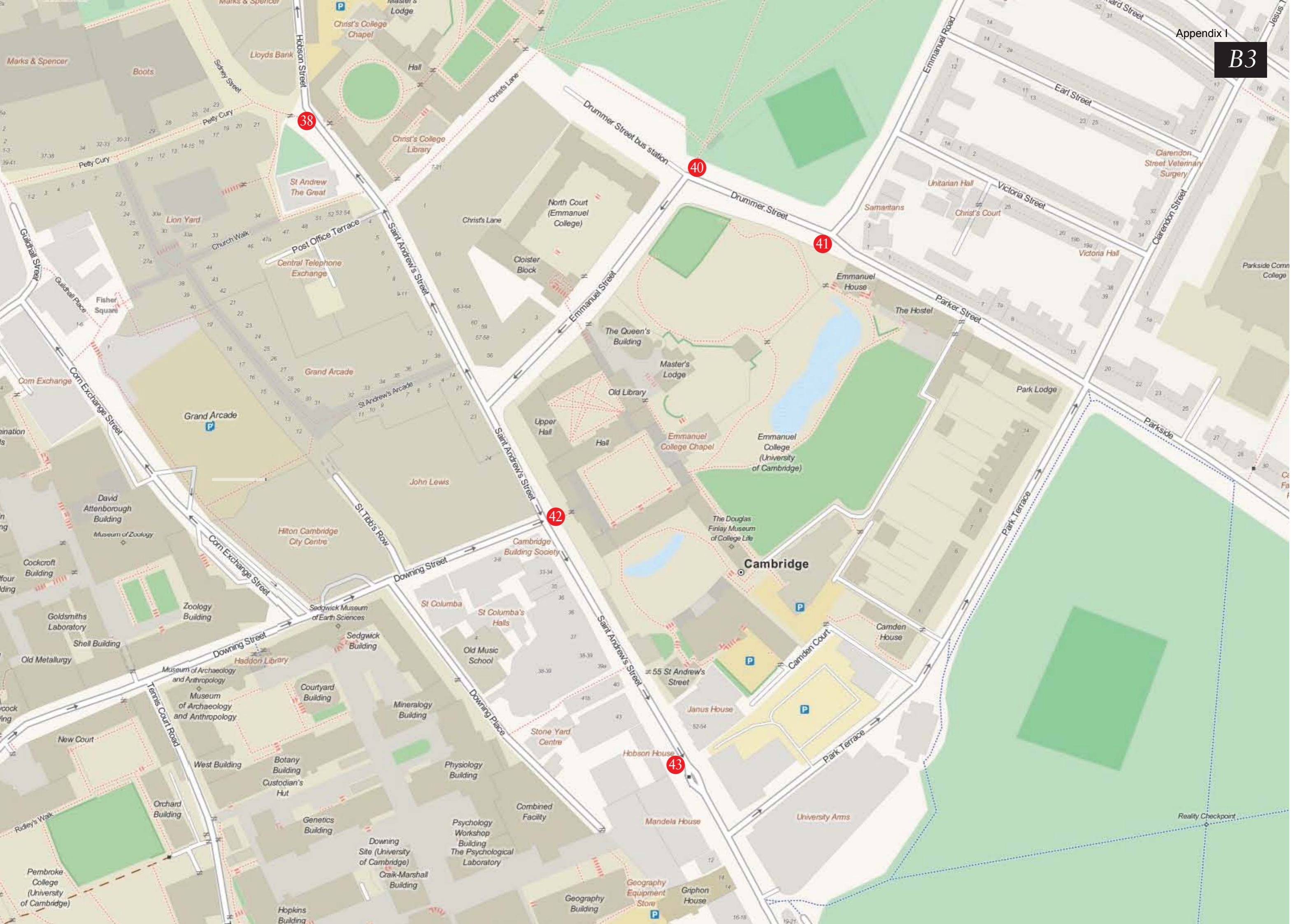

38

40

41

42

43

Cambridge





A603

53

54

55

56

59

60

61

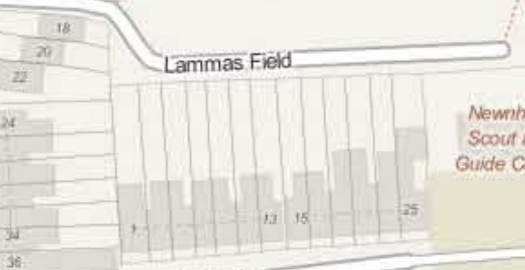

Draft 1

PSPO Notice location document

The following pages present location for the fitting of PSPO notices within Cambridge City Centre.

The signs comply to the following constraints:

- a* Signs are mounted on existing posts, lampposts and suitable street furniture
- b* Signs are mounted at 2.1m minimum height
- c* PSPO signs do not confuse nor clutter existing vehicle warning/information signs

The maximum number of signs required if the more extensive area, as originally proposed in January is subject to the PSPO is 61, however it is estimated that this will reduce to around 50 if the new reduced area currently proposed is agreed. The signs will cost between £30 and £50 per unit with a cost of £20 per sign for fitting, depending on where they are located in the city and the type of street furniture they are attached to.



Location document

1

The following pages relate to locations presented on the 'PSPO Notice Locations Plans', which accompany this document.

Scale 1:4
page set to A4
Copy to be supplied

type **A** small



type **B** medium



type **C** landscape



Specification

Anti-shatter, nonreflective acrylic panel with reverse applied external grade digital print. 3mm radius corners.

Sign panel reverse applied with fixing plate to mount 2 x stainless steel anti-tamper buckle straps.

Anti-tamper buckle straps manufactured from AISI 201 stainless steel.
<http://www.signfix.co.uk>
Part number BS133

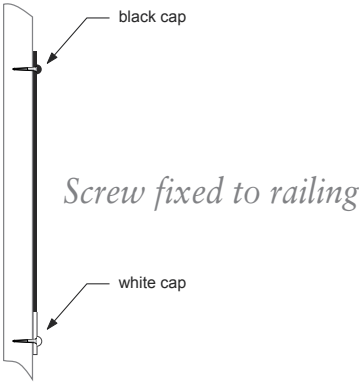
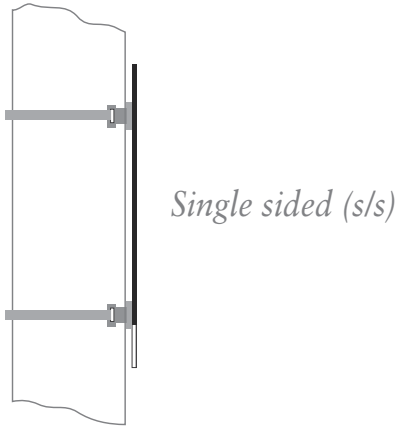
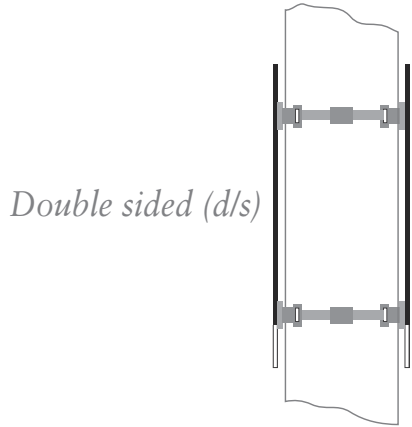
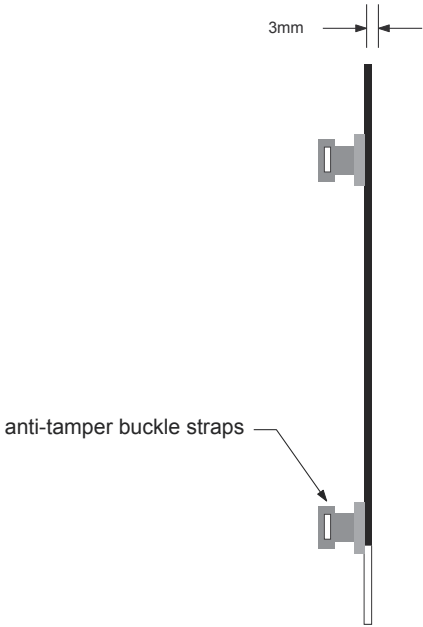

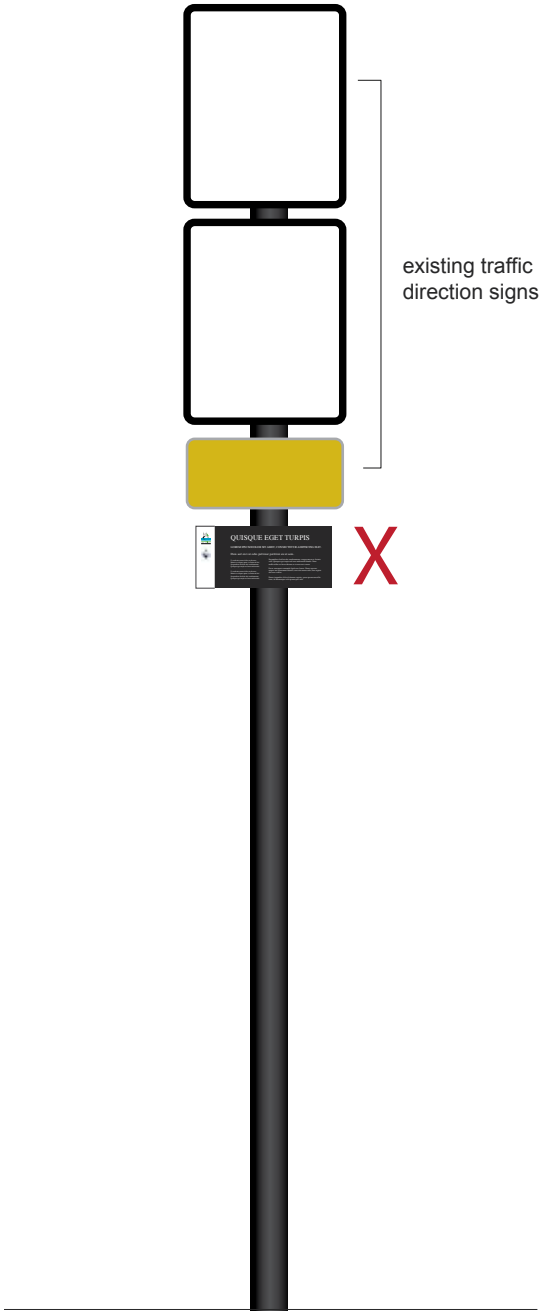
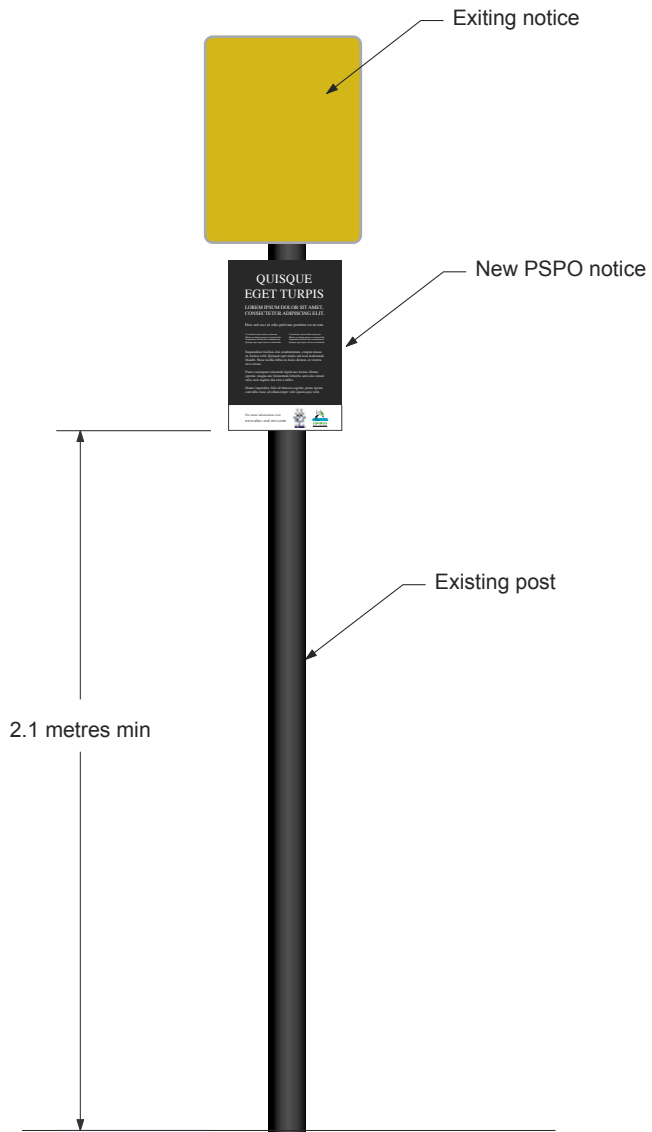

Constraints

- a Signs are to be mounted on existing posts, and lampposts.
- b Signs are to be mounted at 2.1m height or 2.4m if over a cycleway.
- c PSPO signs must not confuse or clutter existing traffic signs where 2 or more traffic signs are present.



1 *A1* PSPO Notice Locations Plan

type *B d/s*

Refer to pages B and C for specification details.



3 *A1* PSPO Notice Locations Plan

type *B s/s*

Refer to pages B and C for specification details.



4 *A2* PSPO Notice Locations Plan

type *B d/s*

Refer to pages B and C for specification details.

5 A1 PSPO Notice Locations Plan

type B s/s

Refer to pages B and C for specification details.



6 A1 PSPO Notice Locations Plan

type B d/s

Refer to pages B and C for specification details.



7 B1 PSPO Notice Locations Plan

type B s/s

Refer to pages B and C for specification details.



8 B1 PSPO Notice Locations Plan

type B s/s

Refer to pages B and C for specification details.



9 B1 PSPO Notice Locations Plan

type B d/s

Refer to pages B and C for specification details.



10 B1 PSPO Notice Locations Plan

type C s/s

Refer to pages B and C for specification details.

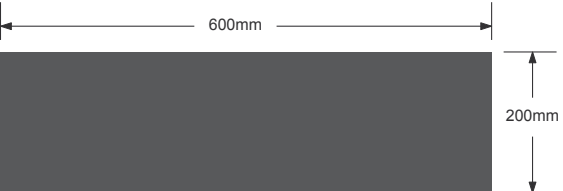

Artwork to be supplied



11 B1 PSPO Notice Locations Plan

type B s/s

Refer to pages B and C for specification details.



12 B1 PSPO Notice Locations Plan

type B s/s

Refer to pages B and C for specification details.



13 B1 PSPO Notice Locations Plan

type B s/s

Refer to pages B and C for specification details.



14 B1 PSPO Notice Locations Plan

type B d/s

Refer to pages B and C for specification details.





14a *B2* PSPO Notice Locations Plan

type *B s/s*

Refer to pages B and C for specification details.



15 B2 PSPO Notice Locations Plan

type *B s/s*

Refer to pages B and C for specification details.

16 B2 PSPO Notice Locations Plan

type A s/s

Refer to pages B and C for specification details.



16a B2 PSPO Notice Locations Plan

type C s/s

Refer to pages B and C for specification details.

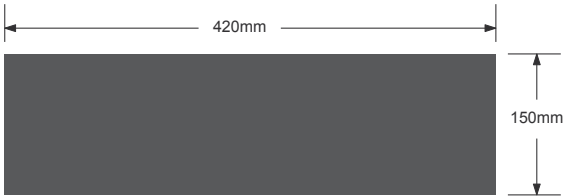

Artwork to be supplied



17 B2 PSPO Notice Locations Plan

type B d/s

Refer to pages B and C for specification details.





18 B2 PSPO Notice Locations Plan

type *B d/s*

Refer to pages B and C for specification details.

19 B2 PSPO Notice Locations Plan

type *B s/s*

Refer to pages B and C for specification details.



20 A2 PSPO Notice Locations Plan

type *C d/s*

Refer to pages B and C for specification details.

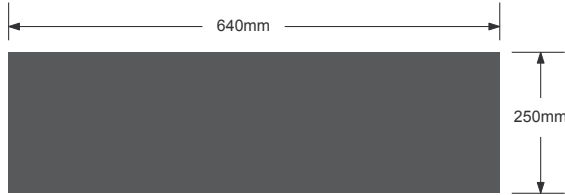

Artwork to be supplied



20a A2 PSPO Notice Locations Plan

type B d/s

Refer to pages B and C for specification details.



21 A2 PSPO Notice Locations Plan

type C s/s

Refer to pages B and C for specification details.



Artwork to be supplied



22 A2 PSPO Notice Locations Plan

type B s/s

Refer to pages B and C for specification details.



23 A2 PSPO Notice Locations Plan

type B s/s

Refer to pages B and C for specification details.





26 A3 PSPO Notice Locations Plan

type *B d/s*

Refer to pages B and C for specification details.

27 A3 PSPO Notice Locations Plan

type *C s/s*

Refer to pages B and C for specification details.

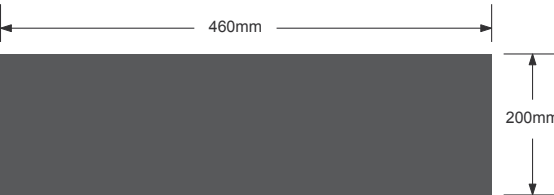

Artwork to be supplied

3 locations along Queen's Rd



28 A3 PSPO Notice Locations Plan

type B d/s

Refer to pages B and C for specification details.



29 A3 PSPO Notice Locations Plan

type C d/s

Refer to pages B and C for specification details.

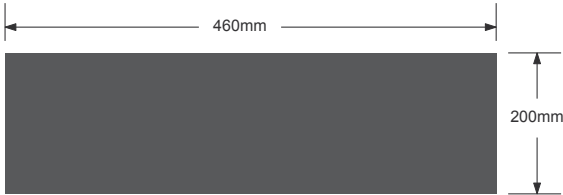

Artwork to be supplied



30 *A3* PSPO Notice Locations Plan

type *Deleted*

Refer to pages B and C for specification details.



31 A3 PSPO Notice Locations Plan

type B d/s

Refer to pages B and C for specification details.



32 A3 PSPO Notice Locations Plan

type B s/s

Refer to pages B and C for specification details.



33 A3 PSPO Notice Locations Plan

type B s/s

Refer to pages B and C for specification details.

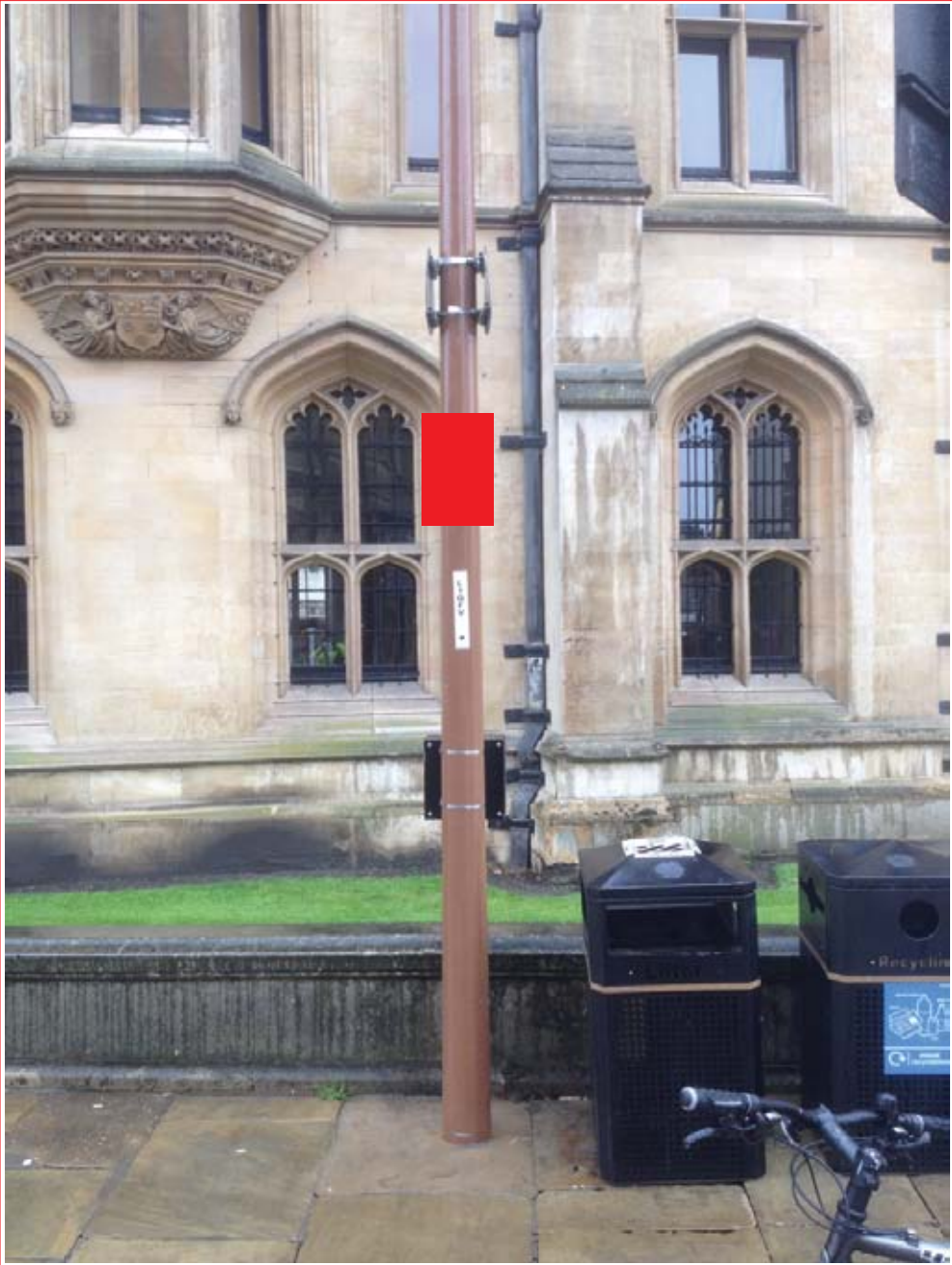

34 A3 PSPO Notice Locations Plan

type B d/s

Refer to pages B and C for specification details.



35 A3 PSPO Notice Locations Plan

type A s/s

Refer to pages B and C for specification details.



36 A4 PSPO Notice Locations Plan

type A s/s

Refer to pages B and C for specification details.



37 *A3* PSPO Notice Locations Plan

type *Deleted*

Refer to pages B and C for specification details.

38 B3 PSPO Notice Locations Plan

type C d/s

Refer to pages B and C for specification details.



Artwork to be supplied





Sign adjacent to Great St Mary's Church

39 A3 PSPO Notice Locations Plan

type *B d/s*

Refer to pages B and C for specification details.

40 B3 PSPO Notice Locations Plan

type B d/s

Refer to pages B and C for specification details.



41 B3 PSPO Notice Locations Plan

type B s/s

Refer to pages B and C for specification details.





42 *B3* PSPO Notice Locations Plan

type *B s/s*

Refer to pages B and C for specification details.

43 B3 PSPO Notice Locations Plan

type B d/s

Refer to pages B and C for specification details.



44 A4 PSPO Notice Locations Plan

type *B d/s*

Refer to pages B and C for specification details.





46 A4 PSPO Notice Locations Plan

type *B d/s*

Refer to pages B and C for specification details.

47 A4 PSPO Notice Locations Plan

type C d/s

Refer to pages B and C for specification details.



Artwork to be supplied



48 A4 PSPO Notice Locations Plan

type B d/s

Refer to pages B and C for specification details.



~~49 52 Deleted~~

50 A4 PSPO Notice Locations Plan

type B d/s

Refer to pages B and C for specification details.



51 A4 PSPO Notice Locations Plan

type *A d/s*

screw fixed to steel gate

Refer to pages B and C for specification details.





53 A5 PSPO Notice Locations Plan

type *A d/s*

screw fixed to steel gate

Refer to pages B and C for specification details.



54 A5 PSPO Notice Locations Plan

type *A d/s*

screw fixed to steel gate

Refer to pages B and C for specification details.

*Fix to steel gates
See location plans*

55 A5 PSPO Notice Locations Plan

56 A5 PSPO Notice Locations Plan

57 Deleted

type *A d/s*

screw fixed to steel gates

Refer to pages B and C for specification details.



58 A4 PSPO Notice Locations Plan

type *B d/s*

screw fixed to steel gate

Refer to pages B and C for specification details.

59 A5 PSPO Notice Locations Plan

type *A d/s*

screw fixed to steel railing

Refer to pages B and C for specification details.





60 A5 PSPO Notice Locations Plan

type *B d/s*

screw fixed to steel railing

Refer to pages B and C for specification details.

61 A5 PSPO Notice Locations Plan

type *A d/s*

screw fixed to steel gate

Refer to pages B and C for specification details.

